



OPERATORS MANUAL



TABLE OF CONTENTS

1 SAFETY INSTRUCTIONS AND WARNINGS.....	4
2 INTENDED USE OF THE MACHINE	6
3 STORAGE CONDITIONS	8
4 OPERATING CONDITIONS.....	8
5 OPERATING INSTRUCTIONS	9
5.1 Washing and disinfection cycles.....	9
5.1.1 Standard cycles / DEKO 260.....	9
5.1.2 Laboratory cycles / DEKO 260 L.....	10
5.1.3 Process diagram.....	11
5.2 Values of the cycles	12
5.3 Process chemicals and variables	12
5.4 Requirements on detergent in Deko washer-disinfectors.....	13
5.5 Process parameters	14
5.6 Required conditions.....	14
5.7 Controls	15
5.7.1 Operating systems	15
5.7.2 Various racks for various loads.....	16
5.7.3 Starting a cycle.....	17
5.7.4 USER-mode	18
5.7.5 Process recording	21
5.7.6 Viewer	23
5.7.7 Malfunction and faults.....	24
5.8 Panel printer.....	26
5.9 Purge and disinfection	27
5.10 Methods of cleaning.....	27
5.11 Flushing of chemical dosing systems.....	28
6 TESTING	29
7 RECYCLING AND DISPOSAL INSTRUCTIONS.....	29
8 DECLARATION OF CONFORMITY	30
9 WARRANTY TERMS AND CONDITIONS.....	31
10 APPENDIX I: FAULT LIST	33
11 APPENDIX II: USER AND MAINTENANCE INSTRUCTIONS.	35

1 SAFETY INSTRUCTIONS AND WARNINGS

When using an electrical appliance, basic precautions should always be followed including the following:

OPERATOR TRAINING

The responsible body shall ensure that all personnel who operate or maintain our machine are trained in its operation and in its safe use. Furthermore to organize regular training of all personnel concerned with the operation and maintenance of the machine.

READ ALL INSTRUCTIONS BEFORE USING THE MACHINE

WARNINGS

The manufacturer cannot be held responsible for damage caused when the appliance is not used according to the instructions, or for uses other than those for which it was intended.

This special commercial machine is suitable for the applications mentioned in the operating instructions. Use only for purposes machine was designed. The manufacturer cannot be held responsible for damage caused by improper use.

Do not allow children or unauthorised personnel access to the machine or its controls.

The process needs to be checked and documented by authorised persons regularly. See EN ISO 15883-1, -2, and IEC 61010-2-040.

The cycles must not be interrupted, as it would cause danger and affect the cleaning and disinfection result. If interruption occurs, do not make an attempt to open door and start the process again. In case the fault condition occurs repeatedly, please call for service. In cases of emergency e.g. fire or flooding, cut off the services to the machine using the safety controls provided externally to the unit. The machine is completely isolated from the electricity supply only when it is unplugged or the circuit breaker is turned off. This must be done before any repair work is carried out.

The machine is constructed in accordance with current safety requirements. Any repairs shall only be carried out by an authorised and a suitably qualified and competent engineer.

The electrical safety of this machine can only be guaranteed if connected to an electrical system complying with all relevant regulations and checked by the regulating authority. The manufacturer cannot be held responsible for damage caused by incorrect wiring.

Installation must be done by suitably qualified and competent contractor. Before connecting the machine, the Installer shall check that the voltage and frequency of the electrical supply correspond with the details on the data plate of the machine.

Only genuine Franke parts or accessories shall be used with the DEKO 260 Washer Disinfector. The performance and safety of non-genuine parts or accessories cannot be guaranteed, and use of such parts or items may void the machine warranty. If you have specific questions about machine options or accessories, please call your supplier.

The water in this machine must not be used as drinking water.

Only use detergents recommended by Franke. Do not use solvents in your machine due danger of explosion.

Take care when handling liquids such as detergents, rinsing or neutralising agents. These may contain acids or alkalis. Follow the instructions and safety procedures on the packaging carefully and wear protective gloves and goggles. Read the Material Safety Data Sheets.

Empty all containers and glassware before placing in machine. Do not allow any acids or solvents, especially hydrochloric acid and chlorides, into the wash chamber.

Be careful when sorting instruments with sharp pointed ends. Place the pointed end downwards if possible.

Install special inserts in accordance with the instructions provided.

When using the machine be careful not to scald or burn yourself. Baskets and inserts must first be allowed to cool down. Water may have collected in incorrectly loaded items is very hot and should be emptied into the wash chamber.

Do not touch the inner surfaces of the wash chamber or the heating elements after the end of program. You could burn yourself.

Do not spray water on the machine.

Do not sit or lean on the open door. This can cause machine to tip and be damaged.

When disposing old machine, make sure the door catch is removed. This will prevent children to be accidentally locked in.

Be careful when removing the panels and working inside the machine because of possible burrs and sharp edges. Use safety gloves if possible.

The manufacturer cannot be held responsible for damage caused by failure to heed the warning and safety instructions.

USED SAFETY SYMBOLS



Dangerous voltage



**Door window is hot during washing and disinfection cycle.
Be aware of the steam discharge.
The goods and racks are hot to handle.
When you handle process chemicals - wear protection
gloves and follow the suppliers' safety instructions.**

2 INTENDED USE OF THE MACHINE

The DEKO 260 Washer Disinfector is suitable for automatic cleaning and thermal disinfection of medical devices intended for re-use such as;

- * Surgical instruments
- * Instrument trays
- * Instruments for minimum invasive surgery
- * Rigid endoscopes
- * Anaesthetic and respiratory equipment
- * Hollowware
- * Glassware and
- * Transit containers

More information in standards:

- EN ISO 15883-1 Washer-disinfectors, Part1: General requirements, definitions and tests
- EN ISO 15883-2 Washer-disinfectors, Part2: Requirements and tests for washer-disinfectors

When processed in the instrument washer-disinfector, the medical devices may be intended for immediate use or packed and sterilised. In both cases the efficacy of the cleaning and disinfection is of major importance. In the first case this is for the well being of the patient, in the latter case it is for the safety of the staff who handles the instruments in the process of inspecting, testing and packing the instruments.

The efficacy of disinfection may be impaired if soil removal is incomplete before the start of the disinfection process. Some medical devices may require pre-treatment e.g. soaking, brushing, ultra sonic pre-cleaning, lumen irrigation or any combination of these techniques.

RESTRICTIONS IN USE

A number of medical devices are excluded from processing in a washer-disinfector altogether. Always follow the Medical Device Manufacturer's instructions for reprocessing the particular item. Re-usable medical devices including hazardous chemicals, gases, materials, parts, components and/or constructions, which do not tolerate water treatment, spray washing and/or heat above +55 Celsius degrees, disposable items, textiles & fabrics, wood, paper & pulp products, tissues and dissolving plastics must not be processed in the DEKO 260 washer-disinfector. The DEKO 260 is not designed for the processing of thermo labile flexible endoscopes (covered in EN ISO15883-1 and15883-4) or re-usable human waste containers (covered in EN ISO15883-1 and 15883-3), laundry or articles used for general catering purposes. DEKO 260 is not intended for the sterilisation of the load as specified in other standards e.g. EN285.

Instruments suitable for processing in a thermal disinfecter

All instruments, accessories, and other items to be cleaned and disinfected in the DEKO 260 Washer Disinfecter should have the following properties:

- Heat resistant to a temperature of up to 138 °C
- Corrosion resistance in the presence of heat and alkalinity

The high heat retention capacity of stainless steel allows for fast drying. Plastics and rubber have a lower heat retention capacity, thus needing a longer drying time. In this case a machine with an integrated drying unit and/or a separate drying cabinet is recommended.

Aluminium discolours. Aluminium only has a limited suitability for processing in this machine.

Carbon steel may corrode in the process. Please try the corrosion resistance of carbon steel instruments with initially one instrument, or do not process carbon steel items at all.

Dental hand pieces, drill bits, grinders, root canal instruments or other rotating instruments only have a limited suitability for the thermal disinfecter. Please ask the manufacturer's advice on the suitability for processing their items in this system.

Rhodium coated specula must be arranged so that their surfaces do not suffer any mechanical damage. Not all specula with glass are suitable for machine treatment.

In case you have any questions regarding the suitability of instruments for being processed in the DEKO 260 Washer Disinfecter, please contact the instrument manufacturer for advice.

3 STORAGE CONDITIONS

Ambient or room temperature 0 °C - +50 °C
Relative humidity, non-condensing 10-90 %
Max. storage time 1 year
Atmosphere Non-corrosive

4 OPERATING CONDITIONS

Electrical ratings

This machine is designed for

Voltage ratings: see 5.5 Electrical connections (Maintenance manual).

Pollution degree

- Pollution degree 2

Installation category

- Installation category II

Maximum relative humidity

80 % for temperatures up to 31 °C

Operating temperature range

- 5 °C to 40 °C

Maximum altitude

- Up to 2000 m

Voltage fluctuation limits of the mains supply

- ± 10 % of the nominal voltage

Over voltage category

Category II (Note! 61010-1, second edition 2001-02 specifies over voltage categories only for measuring equipment)

5 OPERATING INSTRUCTIONS

5.1 Washing and disinfection cycles

5.1.1 Standard cycles / DEKO 260

INSTRUMENT PROGRAM			
Phase	°C	mm:ss	ml
Rinse, cold water		01:00	
Rinse, cold water		01:00	
Wash with detergent	55	05:00	55
Rinse, warm water	55	02:00	
Disinfection $A_0 = 600$	90	01:00	
Drying	85	40:00	
Approximate total time with heating		70:00	

AN – PROGRAM			
Phase	°C	mm:ss	ml
Rinse, warmwater	45	02:00	
Wash with detergent	55	07:00	55
Rinse, warm water	55	02:00	
Disinfection $A_0 = 600$	90	01:00	
Drying	85	40:00	
Approximate total time with heating		75:00	

PLASTICS PROGRAM			
Phase	°C	mm:ss	ml
Rinse, warm water	45	02:00	
Wash with detergent	55	03:00	55
Rinse, warm water	55	02:00	
Disinfection $A_0 = 600$	80	10:00	
Drying	80	30:00	
Approximate total time with heating		65:00	

5.1.2 Laboratory cycles / DEKO 260 L

SHORT LAB			
Phase	°C	mm:ss	ml
Rinse, warm water	45	2:00	
Wash with detergent	55	7:00	55
Rinse, warm water	55	2:00	
Rinse, warm water	55	2:00	
Rinse, pure water	45	2:00	
Approximate total time with heating		30:00	

LONG LAB			
Phase	°C	mm:ss	ml
Rinse, warm water	45	2:00	
Wash with detergent	55	10:00	55
Rinse, warm water	55	2:00	
Rinse, pure water	45	2:00	
Rinse, pure water	45	2:00	
Approximate total time with heating		35:00	

SHORT LAB (INCL. DISINFECTION)			
Phase	°C	mm:ss	ml
Rinse, warm water	45	2:00	
Wash with detergent	55	7:00	55
Rinse, warm water	55	2:00	
Rinse, warm water	55	2:00	
Disinfection, pure water	90	1:00	
Approximate total time with heating		30:00	

Remove unnecessary shelves and racks from the machine. Water valves in the wash chamber are unnecessarily open decreasing water pressure.

5.1.3 Process diagram

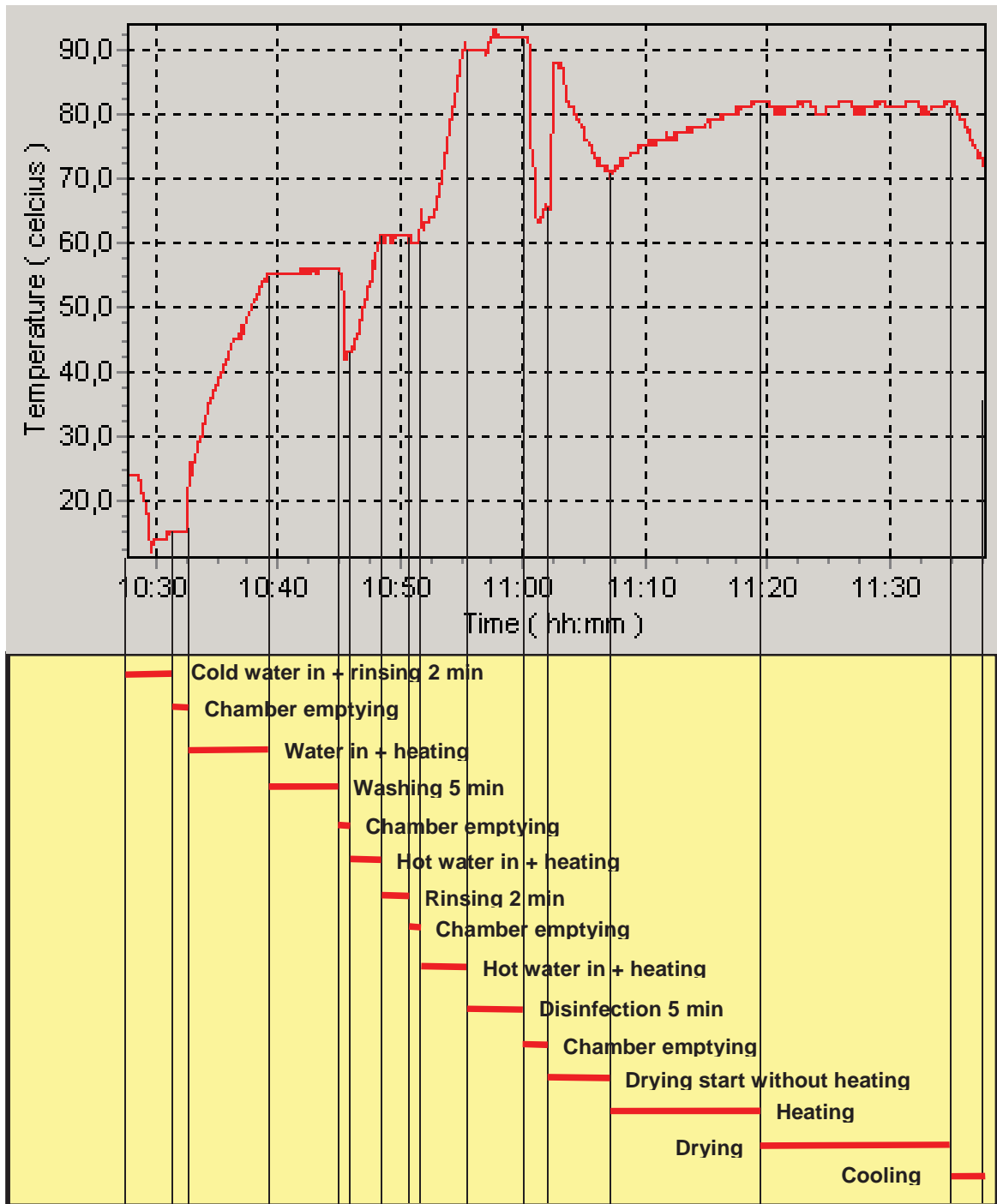

Picture 1: Cycle diagram

Read more from chapter 9.0 Programming (Maintenance manual).

5.2 Values of the cycles

Recommended phase values of the cycles.

	Phase number [P#]	Time, min,sec [t]	Temperature, °C [T]	Chemical volume, ml [Q]	Detergent container, nr	Using of pure water	Dosing temperature, °C [T]
CW-rinse (rinsing with cold water)	1	00,10-10	NA	NA	NA	Yes/No	NA
Wash	2	1 - 25	20-80	15-200	1/2	Yes/No	30-80
HW-rinse (rinsing with hot water)	3	1 - 25	20-80	NA	NA	Yes/No	NA
Disinfection	4	1 - 60	75-95	0-10	NA	Yes/No	NA
Drying	5	15 - 90	50-95	NA	NA	NA	NA
Waiting time	6	It's possible to program a waiting time at the end of the cycle 1-20 min					
<ul style="list-style-type: none"> - Cold water rinse: Only time can be adjusted - Wash: Time, temperature, detergent volume, detergent container number can be adjusted - Hot water rinse: Time and temperature can be adjusted (Note! Selected temperature must be above hot water supply temperature) - Disinfection: Time, temperature and rinse aid can be adjusted - Drying: Time and temperature can be adjusted - Waiting time: Waiting time after the cycle can be used for cooling down the instruments <p>- Pure water can be selected in all water process phases</p> <p>Note!</p> <p>Do not use raw water rinsing or washing after disinfection phase. Set time calculation starts when the required water level and set temperature have been reached - with the exception of drying, whereby the set time is the total phase time.</p>							

Read more from chapter 9.0 Programming (Maintenance manual).

5.3 Process chemicals and variables

DEKO 260 can be equipped with the maximum of 2 adjustable dosage pumps for process chemicals. As standard the machine has one detergent pump only.



Please note that the nature of the item to be processed can require additional actions such as dismantling for separate processing, the pre-cleaning of difficult surfaces (inaccessible sites) by a manual process etc. prior to the item being processed by the machine. Such pre-cleaning can be necessary to reduce the initial bio burden and/or contamination. Please consult the manufacturer of the medical device for processing instructions and note that the cleaning agents and disinfectants used by manual processing must be carefully flushed away with water before the items are loaded into the WD. Failure to do so, may cause excessive foaming and/or pressure drop in the water recirculation system decreasing the cleaning efficacy and extending the cycle time.

Depending on the materials of the medical device being processed a variety of different cleaning agents may be used. Generally, detergents shall be liquid, non-foaming, non-abrasive, free rinsing and biodegradable and have the authorities' approvals for their intended use, as required.

For chromium steel surgical instruments alkaline detergents in the pH range 8 -- 14 are preferred. Usually they may also be used for respiratory equipment. Acid based detergents should only be used for stainless steel items. Medical devices made of aluminium need specific washing agents designed especially for them. Please note that different chemicals may require different process temperatures and times e.g. enzymatic cleaners a temperature between 30 - max 45 degrees Celsius, whereas an alkaline one a temperature between 60 to 90 degrees. The instructions from the manufacturer of the chemical e.g. regarding the concentration and temperature shall be followed. Volume of water in the washing phase is 16 litres.

Please follow the instructions of the manufacturer of the chemical additive for safe handling, data on the biocompatibility (e.g. the maximum permitted residual level on devices). Note that the residual level, which can be tolerated, will depend upon the nature of the chemical and the intended use of the product being cleaned. The specified performance may not be achieved if other process chemicals than those, which have been tested during type testing, or separately with certain process variables, are used.

NOTE! When using special chemicals find out from the chemical supplier the suitability for chamber material AISI 304 (EN 1.4301, BS 304 S31) and chemical dosing system materials PVC and Silicon.

Chemical hoses are marked with the symbols: Detergent  Rinse aid 



When you handle process chemicals - wear protection gloves and follow the suppliers' safety instructions.

5.4 Requirements on detergent in Deko washer-disinfectors

1. Use only liquid detergents.
2. The detergent must be non-foaming. Even a small amount of foam will substantially decrease the cleaning effect.

In case there is plenty of foam in the system the machine is unable to clean the goods and automatic foam removal control will start.

3. The liquid must be free of particles so that nozzles or detergent pump valves will not block.
4. Normally detergents being used are highly alkaline. PH-value is between 10 and 14.

A strongly alkaline liquid will corrode aluminium and its colouring. Please use special washing agents for aluminium items.

The detergents are powerful and must be handled with care. In case of accidental contact with the skin or clothing wash immediately with clean water. For eyes, seek immediate medical attention.

5. Recommended dosage is normally 2-5 g/l.
The used concentration of detergent is related to
- The degree of water hardness
 - The degree of uncleanness
 - The water temperature

Usually washing temperature should be approx. +50...60 °C,
With blood washing temperature is lower.

5.5 Process parameters

See 4.2

5.6 Required conditions

See Technical specifications 5.0 and Installation instructions 6.0 (Maintenance manual).

Water quality

DEKO 260 is designed to operate with potable water (WHO-Guidelines for drinking water quality 1996 refers) supplied directly to it, or with potable water supplied to the water treatment equipment supplying the machine. Water treatment equipment may include e.g. a softener, de-ioniser or reverse osmosis plant, as necessary. Note that many of the attributes of the water supplied to the machine can affect the efficacy and/or efficiency of the process. These include hardness, pH, microbial purity as well as various reactive anions and cations.

Should purified water be required for the process, in addition to the direct supply of potable water, the machine can be equipped with an additional solenoid valve, and in case of a non-pressurised supply, also with an extra feed pump. In order to ensure freedom from microbial contamination, rinse water used in a possible final rinse after disinfection shall be treated as required. For testing the water quality please see EN ISO 15883-1 Chapter 6.4.

Quality of water used in the type tests

For reference, the quality of water used in the process, excluding any final rinse after disinfection, the following values were determined during the microbiological type tests:

Conductivity: 16, 4 mS/m

PH: 8,1

Ox disabes substances (Red ox potential): UH 482 mV

Total hardness (Salts of Ca^{2+} , Mg^{2+} , Sr^{2+} expressed as mmol CaCO_3): 0,59 mmol/l

Total dissolved solids (TDS) determined as evaporative residue: 96 mg/l

5.7 Controls

5.7.1 Operating systems

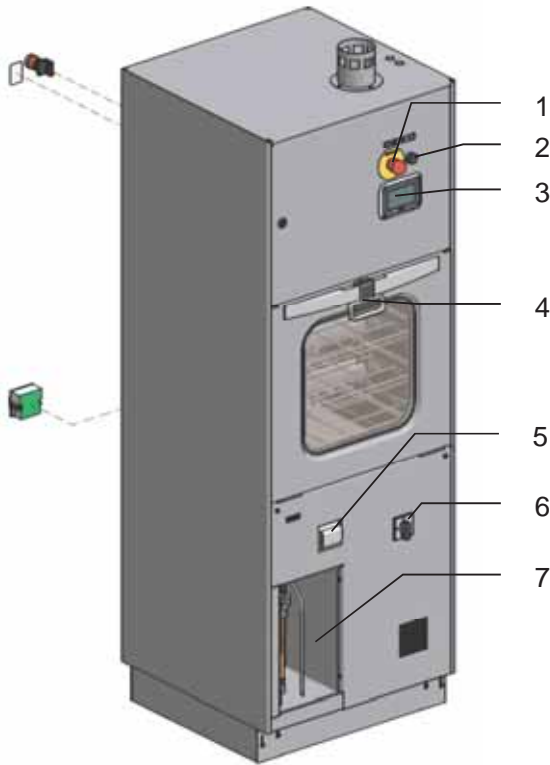

1. Emergency stop (option) (*)
2. USB memory stick connector
3. Main display; touch screen interface
4. Door handle (*)
5. Serial printer
6. Main switch
7. Detergent container (lockable door as option)

(* also on unloading side in pass-through models)

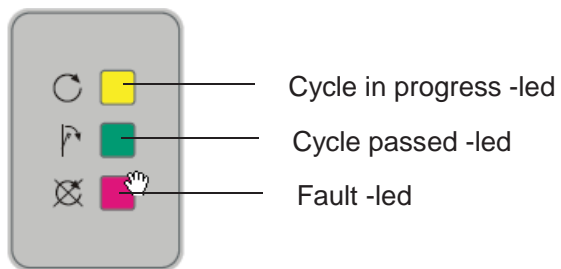

Indication led's on unloading side of pass-through models



Touch screen display for user interface



Alphanumeric keyboard to enter characters

USER = user mode
 PROGRAMMING = programming cycles
 SERVICE = service mode

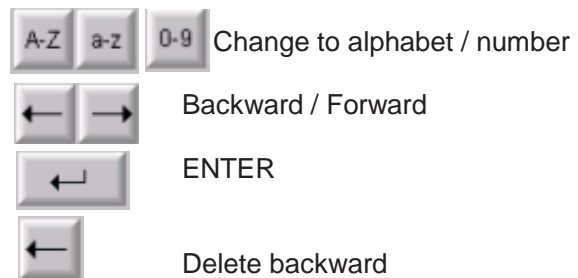

Note !

**The door is interlocked without power.
 Do not close the door without power.**

5.7.2 Various racks for various loads

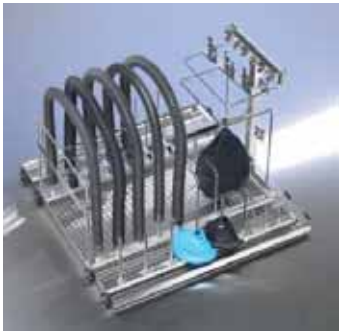

Anaesthesia rack for short hoses

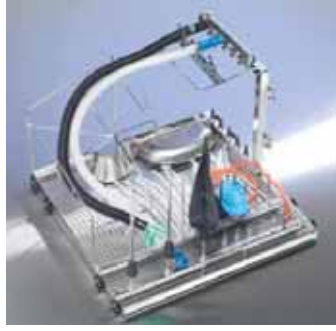

Anaesthesia rack for long hoses



Kidney bowl rack

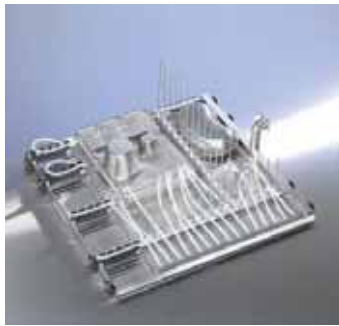

Rigid scope rack



MIS-rack



Laparoscope rack

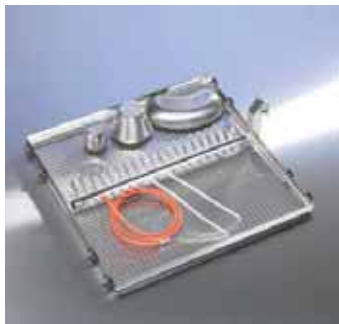

Suction hose rack



Bird hose rack



Shoe rack

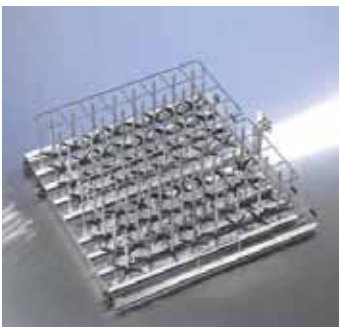

Bottle rack

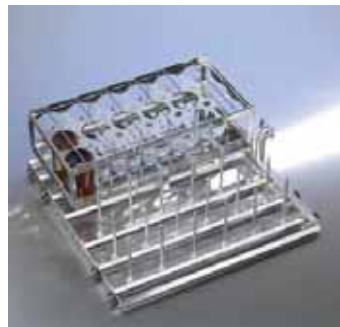

Bottle rack with compartment

5.7.3 Starting a cycle

1. Open all water supply valves (cold, hot, distilled water). Open steam and condense valves, if the machine is heated by steam.
2. Switch the machine ON.

Main menu is displayed once the system starts up:



3. Press "USER" key to enter in user mode



The cycle starting view of user's mode.

5.7.4 USER-mode

START displays below illustrates the choice of max 6+6 different cycles.

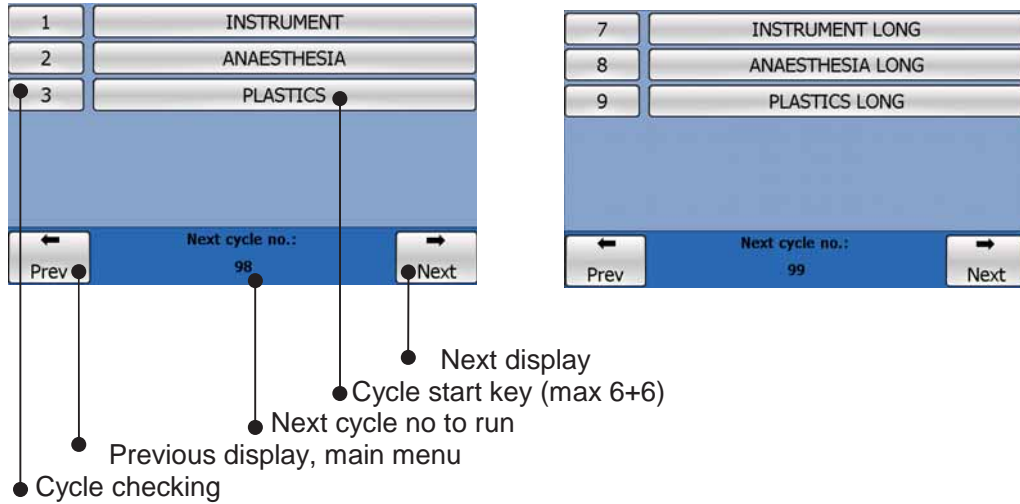

Start the cycle

Open the door, load the machine and close the door



Start the wanted cycle by pressing the start key. If needed, by pressing “Cycle checking” key, the steps and variables of the cycle can be checked.

NOTE! The cycle variables i.e. temperatures, times and chemical dosage volumes, are pre-set and cannot be adjusted prior to, or during the cycle. Possible changes to the pre-set cycles may only be made by using a special code and into the cycle set-up. Validated, factory set cycles, however, cannot be modified.

If the machine is unused for a period of ten minutes it will go into standby mode. By pressing the “CONTINUE” key this will bring the machine out of standby and open the door interlock.



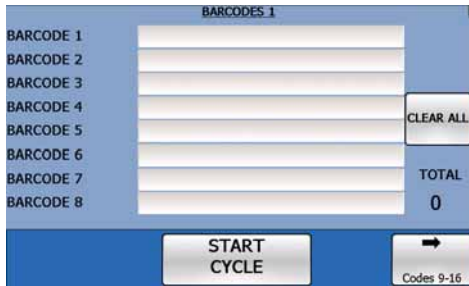

Read the baskets and instruments (option)



Enter the user ID if required.



The selected cycle may be cancelled by pressing the CANCEL key within 5 sec's.



If the cycle does not include disinfection phase this will be warned on display

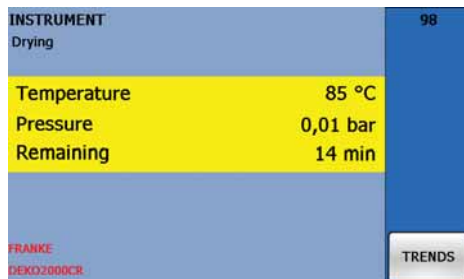

During a cycle the display will indicate:

Name of cycle / cycle phase / chamber temperature / pump pressure / remaining cycle time / ongoing cycle number and 'Trends' key for temperature and pressure graph viewing.

All events are printed (option) during the cycle. (See 4.8 Panel printer)

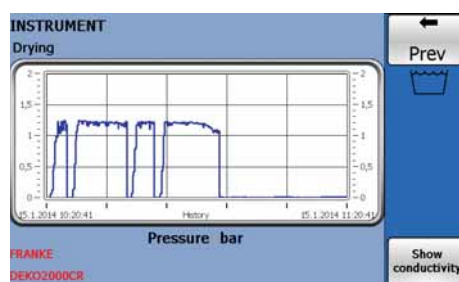
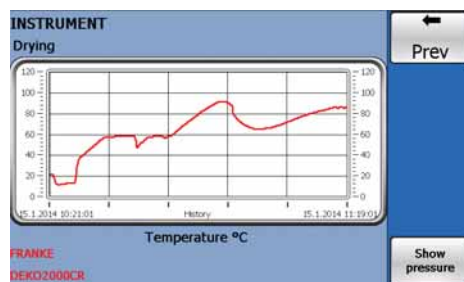

If the machine is provided with water conductivity meter, the conductivity curve can be seen too.

End of cycle

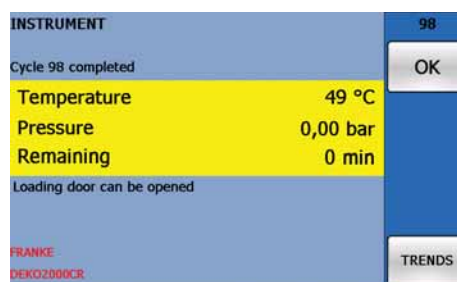

The end of the cycle will be indicated with an audible buzzer and the text “loading/unloading door can be opened”. If the machine is pass through model, the cycle complete-led (green) on unloading side will go ON. In special cases a double door machine can be used as a single door machine, there is a key “Open loading door”, see 8.4 Process parameters (Maintenance manual) .

Open the door and unload the chamber.

Beware of hot items and load carriers after opening the door. It's recommended load items to cool down sufficient time (e.g. 1 min) before unloading !

Note ! The door is interlocked without power



Press OK and return to the Cycle start view.

NOTE ! In pass through model the loading door can not be opened before unloading door is opened.

NOTE ! If the cycle did not include disinfection phase, this will be warned on display and both cycle complete-led and fault -led will go ON (unloading side).

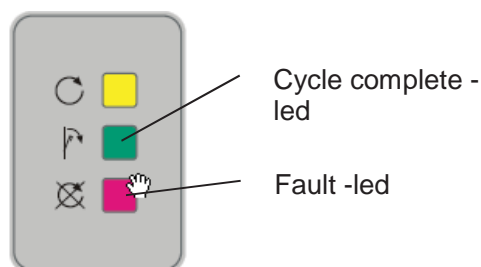

5.7.5 Process recording

Cycles are recorded automatically on SD memory card and/or on FTP server by Ethernet connection.

Recording on SD Memory Card:

The SD Memory Card shall be inserted in its place of the terminal. The machine automatically creates a folder named Cycle Data on the empty Memory Card and under the Cycle Data folder is created every day (when the machine is in use) a "date folder" which is named after the date (e.g. 2003-04-03). All washing cycle files are recorded under the date folders. Format of the recorded cycle file is e.g. AH01_00952.dko:

First 4 characters (here AH01) mean the individual name of the machine. Last 5 characters (here 00952) mean the batch number in question.

The cycle files can be opened by using SD-card reader or saving on USB-memory stick

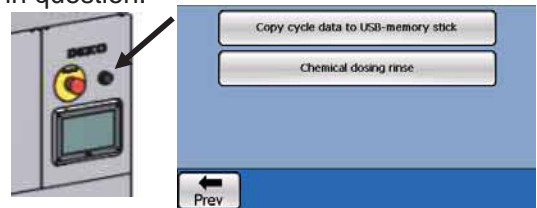

How to copy cycle files on USB memory stick:

Insert an empty USB memory stick to connector above the terminal. In user's mode press "Next" –key to find "Copy cycle data to USB memory stick"-key, by pressing it the copying starts automatically. Wait until you see on the display that all files have been copied on the memory stick. Now the stick can be removed and the cycles can be viewed with computer.

WARNING:

The memory card must only be removed or Inserted into the machine in standby mode. Attempting to remove the memory card at any other time may result in permanent damage to the card.

When transferring files from the memory card to the PC removal of the card must not take place during use as again this may result in permanent damage to the card.

Name ▲	Size	Type	Modified
Folder Cycle Data		File Folder	24.3.2003 13:49
2003-03-27			
2003-03-31			
2003-04-01			
2003-04-03			
2003-04-04			

Name ▲	Size	Type	Modified
AH01_00947	5 KB	DKO File	3.4.2003 13:05
AH01_00948	4 KB	DKO File	3.4.2003 13:14
AH01_00949	2 KB	DKO File	3.4.2003 13:16
AH01_00950	4 KB	DKO File	3.4.2003 13:27
AH01_00951	2 KB	DKO File	3.4.2003 13:30
AH01_00952	4 KB	DKO File	3.4.2003 13:40

Recording on FTP-server:

This feature is an OPTION. If the machine is connected with local network (Ethernet), the recorded cycle data can be saved on FTP-server.

Below is the recorded cycle **AH01_00952.dko** opened by Notepad (is installed in every PC).
 Using the Notepad program the file can be seen in text format. (Temp1:= controlling temperature sensor;
 Temp2: = verifying temperature sensor; Pres1: = controlling pressure sensor; Pres2: = verifying pressure sensor)

Machine Number: AH01
 Instrument Trays:

Batch Number: 952
 Institution Name: FRANKE
 Operator ID-Number: 2314
 Cycle Start Time: 07/03/2006 10:41:47
 Cycle Name: INSTRUMENT
 Validated Cycle: FALSE

Time:	Temp1:	Temp2:	Pres1:	Pres2:
-10:41:49	21	21	0.01	0.00
Cold water rinse start				
-10:41:51	21	21	0.02	0.00
.....				
-10:45:32	19	19	1.05	0.08
Cold water rinse end				
Wash 55°C start				
-10:46:31	20	19	0.01	0.01
.....				
-10:57:56	46	46	0.68	0.69
Detergent dosed: 20 ml				
-10:57:58	46	46	1.13	1.15
.....				
-11:01:34	56	56	1.12	1.13
Temperature attained T:56°C p:0.64 bar				
-11:01:36	56	56	1.08	1.10
.....				
-11:06:36	57	57	1.13	1.15
Wash end T:57°C p:0.65 bar				
-11:06:38	56	57	1.16	1.18
Rinse start				
-11:07:33	56	56	0.01	0.01
.....				
-11:19:29	56	56	0.66	0.65
Temperature attained T:56°C p:0.61 bar				
-11:19:31	56	56	1.16	1.17
.....				
-11:21:30	56	56	1.13	1.15
Rinse end T:56°C p:0.68 bar				
Disinfection 90°C start				
-11:22:29	56	56	0.02	0.01
.....				
-11:44:51	91	91	0.65	0.65
Temperature attained T:91°C p:0.73 bar				
-11:44:53	91	91	1.03	1.05
.....				
-11:45:30	92	92	1.06	1.07
Rinse aid dosed: 0 ml				
-11:45:32	92	92	0.64	0.57
.....				
-11:45:52	92	93	0.63	0.63
Disinfection Time: 60 s				
Disinfection end T:93°C p:0.63 bar				
Waiting time 2 min				
-11:49:25	63	64	0.01	0.01
.....				
-11:51:24	63	63	0.01	0.00
Cycle End Time: 07/03/2006 11:51:24				
Cycle PASS				

CheckSum: d56a

5.7.6 Viewer

The recorded cycle curves can be seen using Deko Cycle Data Viewer-program.
The program is opened by double clicking the Shortcut of the viewer:

 DEKO Cycle Data Viewer

The wanted cycle data is opened by pressing  -key and then double clicking the data file.

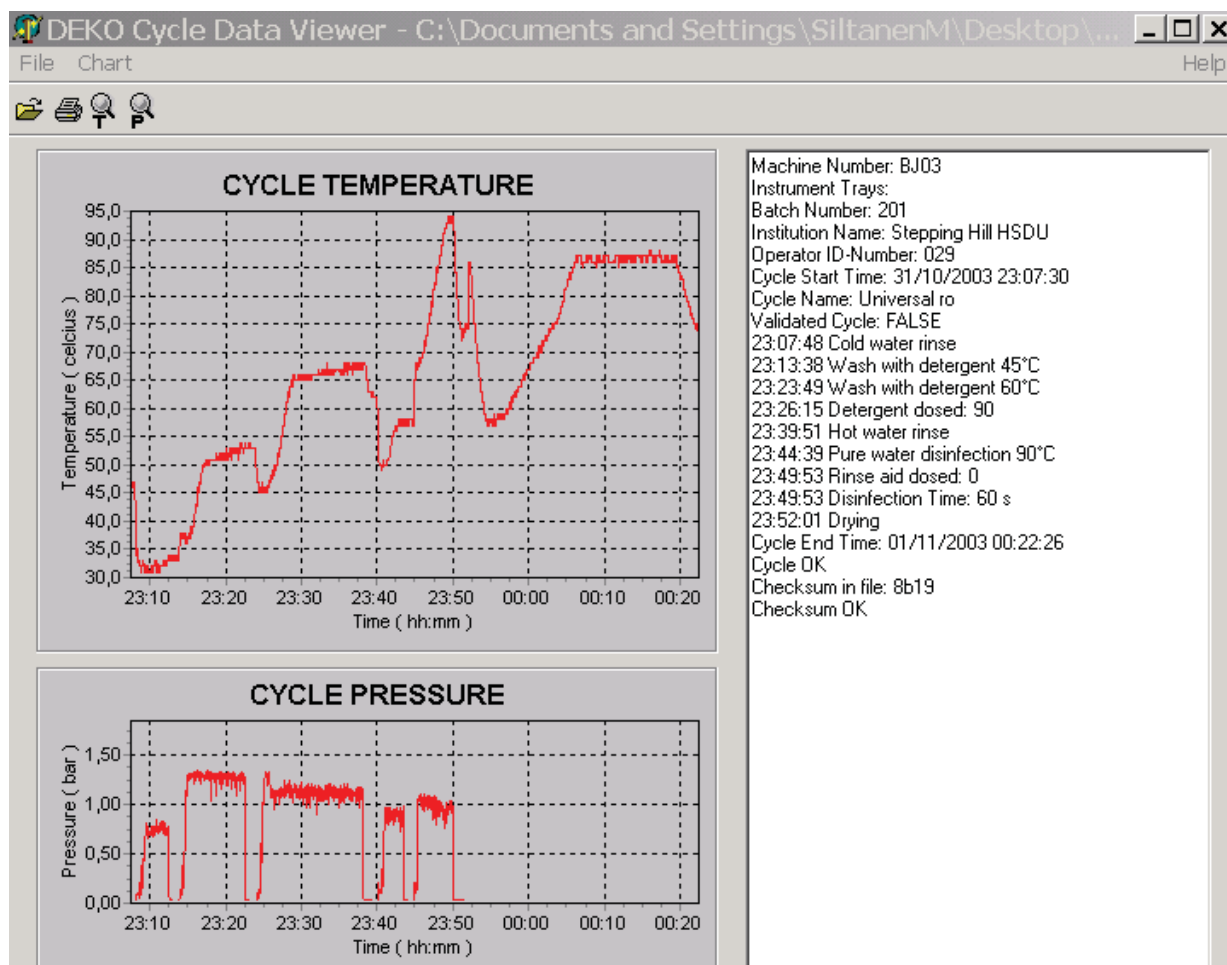

Zoom temperature: Select a rectangular area from the display by pressing left button of the mouse and release the button. By pressing right button the curve can be moved on the display. Quit zooming.



Zoom pressure: Same as above.



Print Charts: By pressing PRINT CHARTS key, first question is "Do you use colorprinter". Select No, if you do not have a colorprinter.

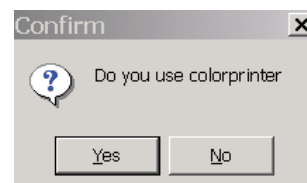

5.7.7 Malfunction and faults

WARNING situations, which can be controlled by the User, are being indicated as shown below. If the recommended actions have been taken, press the “CONTINUE” key . After the fifth indication (door open or lack of chemical) the machine will switch over into FAULT condition.



Press “CONTINUE” key to confirm the warning message.

Warning messages

Warning text	Explanation
No disinfection	Warns the user, if the cycle does not include disinfection
Cycle nr. xx OK, No disinfection.	Warns the user, if the cycle did not include disinfection
Loading door is open	Loading door open or not closed correctly
Unloading door is open	Unloading door open or not closed correctly
Chemical tank 1 empty.	Replace chemical tank #1
Chemical tank 2 empty.	Replace chemical tank #2
Periodic service is needed	Inform the service to perform periodic service
Rinse aid tank empty.	Replace rinse aid tank
Air filters are dirty	Inform the service department to change the air filter
Power cut off during the cycle	There has been a power failure during the last cycle THE CYCLE MUST BE RUN AGAIN !
Check parameters	Call service
Set parameters	Call service, machine must be configured
Recording error	Call service
Printing error of report	Call service
Transfer of ftp file failed	Call service
Parameter of machine type	Call service
Downloading of parameters	Call service

Fault messages

In a Fault condition the fault display appears with the fault code. On unloading side the FAULT- led turns red. By pressing **Info** the possible cause and recommended actions for the repair will be displayed. Service shall always be contacted and called for, if a Fault condition occurs.

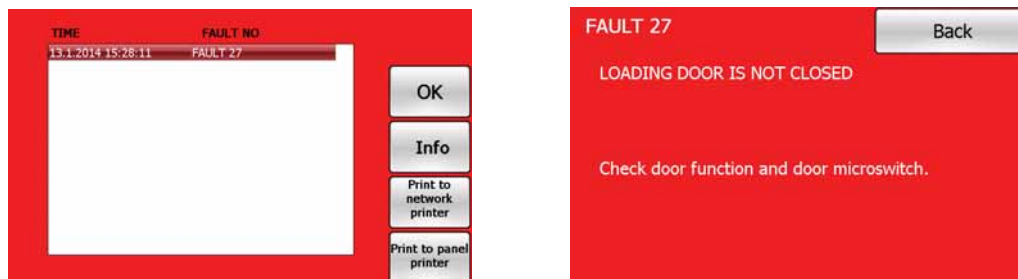

By inserting the service code the chamber will be emptied automatically to avoid danger of hot water.

The load must be reprocessed (the selected cycle must be run again) always after incomplete cycle !

Nr	Fault message	Nr	Fault message
1	Loading door has opened during the cycle	31	Unloading door stayed interlocked
2	Controlling temperature sensor T1 has short circuit	32	Loading door interlock opened during the cycle
3	Controlling temperature sensor T1 has open circuit	33	Pressure sensor p1 has short circuit
4	Verifying temperature sensor T2 has short circuit	34	Chemical dosing under set value, pump 1
5	Verifying temperature sensor T2 has open circuit	35	Chemical dosing under set value, pump 2
6	Unloading door has opened during the cycle	36	
7	There is not enough water in the chamber	37	
8	There is water left in the chamber	38	Chemical tank 1 empty
9	Water heating failed	39	Chemical tank 2 empty
10	Pressure of circulation water too low	40	
11	Overflow in chamber	41	Rinse aid tank empty
12	Chamber drained at wrong time	42	
13	Water temperature above set limit	43	Drying air pressure too low.
14	Pressure of circulation water dropped too low	44	Flap of drying coil casing not open.
15	Drying air filters are unclean	45	Flap of drying coil casing not closed.
16	Difference between temperature sensors T1 and T2 is too high	46	
17	Air heating failed	47	
18	Drying temperature not reached in 40 mins	48	Pressure sensor p2 has short circuit
19	Drying temperature above set limit	49	Difference between pressure sensors is too high
20	Communication failed between PLC and operating panel	50	Unloading door interlock opened during the cycle
21	Water pump's thermal relay tripped	51	Unloading door is not closed
22	Pure water pump's thermal relay tripped	52	Electric board temperature too high
23	Water temperature below set limit	53	
24	Drying temperature below set limit	54	
25	Loading door not interlocked	55	
26	Loading door stayed interlocked	56	
27	Loading door is not closed	57	
28	Drying valve not open	58	Pure water conductivity over set limit
29	Drying valve not closed	59	
30	Unloading door not interlocked	60	Steam cooler overflows

5.8 Panel printer

DEKO 260 is equipped with a panel printer. It prints cycle report with all basic data and events. The printer is a thermal printer and the paper report is archiveable.

Cycle report is printed automatically during the process.

There is one button with a led on top right to feed paper and to indicate the status of printer.



The thermal paper with preservability of 10 years can be ordered from Franke or it's representatives.

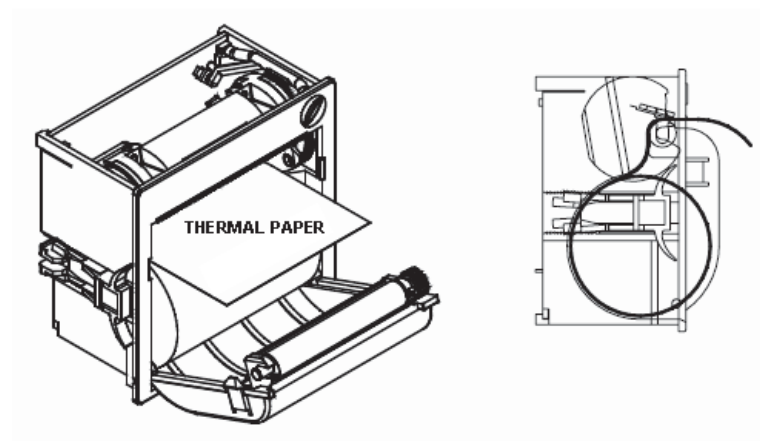

Install the paper according to the picture above.

Cycle Report:
Owner: PMK Hospital
Machine: 4
Cycle Name: INSTRUMENT
Cycle number: 1452
Cycle start time: 06-08-17
15:45:03
15:45:10 CW rinse start
15:46:34 CW rinse end
15:46:37 Wash start
15:47:26 Chem flow OK
15:47:30 Chem : set 50 ml
T:47 °C
15:47:35 Temperature attained
T:50 °C p: 1.05 bar
15:48:30 Wash end
15:48:33 HW rinse start
15:49:30 Temperature attained
T:50 °C p: 1.04 bar
15:49:30 HW rinse end
15:49:33 Disinfection 90 °C start
15:55:21 Temperature attained
T: 90 °C p: 1.01 bar
15:56:26 Disinfection end
T:91 °C p: 1.00 bar
15:56:30 Disinfection time 60s
15:56:33 Drying start
16:36:34 Drying end
Cycle end time:06-08-17 16:36:45
Cycle passed

signature

Cycle print

5.9 Purge and disinfection

All parts of the machine supplying fluids to the load or chamber are purged and disinfected during a normal operating cycle. The wash chamber and pipe work of the machine have been designed so that any remaining process water shall flow towards the discharge point of the machine.

It is recommended to run a short cycle with disinfection if the machine has not been used in 24 hours.

Warning: Chamber and pipe work may contain harmful micro-organisms after malfunction!

5.10 Methods of cleaning

Daily:

Check that all the sprayers rotate freely and spray holes are open
In case the fixed or rotating nozzles get blocked the cleaning effect will deteriorate. Please take care of keeping the nozzles clear

Weekly:

Clean the outlet sieve by brushing it a few times with the brush.
Clean the outer stainless steel panels with diluted washing agent and soft washcloth.

Cleaning of the chamber:

Ask from the chemical supplier a special chemical with an acidic pH value for cleaning of washer disinfector's chamber surfaces (stubborn lime, dirt and rust stains and oxide films).
The dosing volume is generally informed as ml / water volume or % / water volume.
E.g. if the recommended dosage is 1 %, it means with Deko 260 (water volume 16 l)
160 ml of chemical ($16 \text{ l} * 1 \% / 100 = 0.16 \text{ l} (= 160 \text{ ml})$).

The non-foaming special chemical shall be poured into open bowl and put on the washing shelf.
The chemical is diluted automatically into the washing water during the cycle.
Note ! Do not pour acid based chemical to the chamber bottom, it may cause damages to the parts and surfaces.

The cleaning cycle is made in programming mode, see maintenance manual chap. 9.

An example of cleaning cycle:

Wash	20 min	55 °C
Hot water rinse	2 min	55 °C
Hot water rinse	2 min	55 °C

Ask more detailed information about the dosage and temperatures from the chemical supplier.



When you handle process chemicals - wear protection gloves and follow the suppliers' safety instructions.

5.11 Flushing of chemical dosing systems

To avoid problems in chemical dosing like solidified detergent and blocked piping it's very important to flush the system regularly with hot water.

It's recommended to flush the dosing systems every two weeks and always whenever the detergent container is changed.

Fill a container with hot tap water and put the detergent suction tubes into the container. In user's mode press "Next" –key to find "Chemical dosing rinse"-key, by pressing it the chemical dosing systems in use can be flushed.

e.g. by pressing "Chemical 1"-key the pump starts and rotates for 30 sec

If the dosing system is in order, the number of pulses is about 1000 – 1300 with water.

If needed repeat the flushing.

Put the suction tubes into the detergent container and turn on the pumps once again to refill the system with the current detergent.

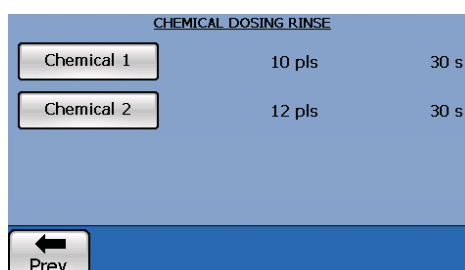
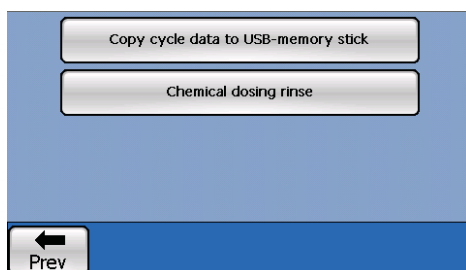

6 TESTING

Tests for operational, performance and routine testing are described in standard **EN ISO 15883-1**, Washer-disinfectors Part 1: General requirements, definitions and tests; Chapter 6 Testing for conformity and in the Informative Annex D.

See also **EN ISO 15883-2**, Washer-disinfectors-Part 2: Requirements and tests for washer-disinfectors employing thermal disinfection for surgical instruments, anaesthetic equipment, hollowware, utensils, glassware etc.

They may be used in type tests, work tests, and in validation and re-validation tests, or in periodic routine tests carried out by the user.

7 RECYCLING AND DISPOSAL INSTRUCTIONS

Packing materials are recyclable. Dispose in accordance with local regulations.

Electronic control cards and components shall be removed and delivered to respective collection places.

Machine framework and other metal parts can be recycled and delivered to metal collection places.

Please follow the instructions and regulations of the local authorities by the disposal of a used machine.

8 DECLARATION OF CONFORMITY

Manufacturer: FRANKE MEDICAL OY

Address: Vartiokuja 1, 76850 Naarajärvi, FINLAND

Hereby declares that:

DEKO 260 complies with the following Directives:

- Medical Device Directive (93/42/EEC).
- The Restriction of Hazardous Substances Directive (RoHS 2011/65/EU)

And that the following harmonized standards have been applied:

- EN 61010-1 Safety requirements for electrical equipment for measurement, control, and laboratory use
General requirements
- IEC 61010-2-040 Particular requirements for washer disinfectors used in medical, pharmaceutical, veterinary and laboratory fields.
- EN 61326-1 Electrical equipment for measurement, control and laboratory use.
EMC requirements.
- EN ISO 13485 Medical devices. Quality management systems. Requirements for regulatory purposes (ISO 13485:2003)
- EN ISO 15883-1 Washer-disinfectors, Part1: General requirements, definitions and tests
- EN ISO 15883-2 Washer-disinfectors, Part2: Requirements and tests for washer-disinfectors employing thermal disinfection for surgical instruments, anaesthetic equipment, hollowware, utensils, glassware etc.



This product complies with the essential requirements of the applicable European laws and Directives with respect to safety, health, environment and consumer protection. Design, manufacture and final inspection in Franke Medical Oy are evaluated by **VTT** which Notified Body is no. 0537 under the Council Directive 93/42/EEC.

(Signature)
Antero Asikainen, Managing Director

9 WARRANTY TERMS AND CONDITIONS

Dear Deko Customer,

Rhima Australia warrants the Deko Washer Disinfectors to be free from defects in material and workmanship under "normal use and service", which does not include normal wear and tear or preventative maintenance service. Specifically not covered by warranty are service calls to adjust thermostats, detergent dispensers, user errors, racks and accessories, commissioning or any other service requirement not strictly related to defects in material or workmanship.

Rhima Australia will repair or replace any parts, **which in Rhima Australia's sole judgment**, are defective in material and/or workmanship. No responsibility will be accepted for repairs, defects or damages due to improper installation, misuse or neglect. The Deko machines are manufactured with great care; prior to delivery they must pass an extensive quality control. If your machine shows any material or manufacturing defect, you will have a legitimate claim.

The following conditions apply and if in doubt, please refer to our general terms and conditions:

1. Within the warranty period we shall repair any faults with your Deko machine, free of charge, if caused by a material or manufacturing defect. Replaced defective parts will be returned to us and become our property. Warranty is 12 months on parts. In state capitals (within a 30 km radius of GPO) a 3-month warranty on labour, to replace defective parts, applies. All other areas are not covered by a labour warranty, unless specifically mentioned in writing. In any case, **warranty repairs are only carried out within normal business hours** (Monday to Friday, 08.00-17.00 hrs, excluding public holidays).
2. The warranty period starts on the commissioning date. The commissioning must be undertaken within 1 month of machine delivery or warranty will commence from the delivery date.
3. A warranty claim is not valid for defects caused by tampering or repair work carried out by unauthorized persons. This also applies to the fitting of additional accessories, which were not designed for our machines.
4. If a machine, which has been repaired within the warranty period, develops the same fault within 3 months after the repair, the fault will be repaired free of charge, if the cause for this defect is inexperienced repair work, or a material or manufacturing defect of the replaced spare parts, or of the replaced machine. Otherwise the warranty period will not be extended by warranty work.
5. Additional or different claims, especially those for damages caused outside the machine are invalid, unless a liability is enforced by law.
6. All warranty call outs must be approved by Rhima and have an order number.
7. The following is expressly excluded from warranty claims:
 - service or parts relating to blockages due to misuse
 - defects to racks and accessories
 - service or parts relating to inlet and outlet hoses
 - adjustments to temperatures, (water)levels, detergents etc
 - incorrect use or incorrect installation
 - any breakdown due to external influences (high or low water temperature /pressure/ quality, interruption of electricity supply etc)
8. If you call, please have the following information ready:
 - date of purchase (see invoice/receipt)
 - type of defect / description
 - Machine serial number *

For full information on warranty conditions, please refer to our general terms and conditions, which are available on request.

*** EACH MACHINE HAS A SERIAL NUMBER. WARRANTY CLAIMS WITHOUT THIS NUMBER WILL NOT BE TAKEN INTO CONSIDERATION. THIS NUMBER IS LOCATED INSIDE THE DETERGENT DOOR ON THE LEFT SIDE PANEL.**

10 APPENDIX I: FAULT LIST

Nr	Fault message	Explanation
1	Loading door has opened during the cycle.	Check and adjust solenoid lock and micro switch of the door.
2	Controlling temperature sensor T1 has short circuit.	Check connections or change sensor
3	Controlling temperature sensor T1 has open circuit.	Check connections or change sensor
4	Verifying temperature sensor T2 has short circuit.	Check connections or change sensor
5	Verifying temperature sensor T2 has open circuit.	Check connections or change sensor
6	Unloading door has opened during the cycle.	Check and adjust solenoid lock and micro switch of the door.
7	Water intake is blocked, not enough water in chamber.	Check water supply solenoid valves and water level switch. Clean mud filter.
8	There is water left in the chamber.	Check the level switch, outlet valve and drain.
9	water heating failed	Check the heating contactors, overheating protector and heating coils.
10	Pressure of circulation water does not rise in the start of the cycle.	Check the pressure transmitter, circulation pump, and water inlets.
11	Overflow in chamber	Check the inlet valves for leakage. Check water levels and drain outlet.
12	Chamber drained at wrong time.	Check drain outlet function
13	Water temperature above set limit	Check contactors, check hot water supply temperature
14	Pressure of circulation water dropped too low	Check foaming, check pump function, chamber sieve, pressure sensor
15	Drying air filters are unclean.	Change filters. Reset the filter change in service mode.
16	Difference between temperature sensors T1 and T2 is too high	Check sensors T1 and T2 Calibrate sensors T1 and T2
17	Air heating failed. Check heating relays and coils.	Check heating contactors, overheating protector and heating coils.
18	Air temperature set point not reached in 40 minutes.	Check heating contactors, overheating protector and heating coils.
19	Air temperature above set limit	Check contactors and sensors. Air exhaust blocked.
20	Communication between terminal and logic failed.	Check connections and restart. Change terminal or logic module or cable.
21	Water pump's thermal relay tripped	Pump's current consumption is too high. Check fuses / reset thermal relay. Check if pump is jammed, objects in pump.
22	Pure water pump thermal relay tripped	Pump's current consumption is too high. Check fuses / reset thermal relay. Check if pump is jammed, objects in pump.
23	Water temperature below set value	Check heating contactors, overheating protector and heating coils.
24	Air temperature below set limit	Check contactors and heating coils. Check temperature sensors. Check there is air gap at exhaust vent.
25	Loading door lock not interlocked	Check door interlock's functions
26	Loading door stayed interlocked	Check door interlock's functions
27	Loading door is not closed.	Check door micro switches, door function.
28	Drying valve not open	Check the function of drying valve
29	Drying valve not closed.	Check the function of drying valve
30	Unloading door not interlocked	Check door interlock functions
31	Unloading stayed interlocked	Check door interlock functions
32	Loading door interlock opened during cycle	Check door interlock functions
33	Pressure sensor P1 has short circuit.	Check connections, change the sensor.
34	Fault in chemical dosing, pump 1.	Check pump, hoses and pipes. Check flowsensor function. Calibrate pump and flowsensor. To clean flush the system with warm water.
35	Fault in chemical dosing, pump 2.	Check pump, hoses and pipes. Calibrate pump and flowsensor. Check flowsensor. To clean flush the system with warm water.

36	Not in use	
37	Not in use	
38	Chemical container 1 empty.	Fill up container or detector is faulty.
39	Chemical container 2 empty.	Fill up container or detector is faulty.
40	Not in use	
41	Rinse aid container 1 empty.	Fill up container or detector is faulty.
43	Drying air pressure too low.	Check air fan and pressure difference switch.
44	Flap of drying coil casing not open.	Check function of the flap actuator.
45	Flap of drying coil casing not closed.	Check function of the flap actuator.
46	Not in use	
47	Not in use	
48	Pressure sensor P2 has short circuit.	Check connections, change the sensor.
49	Pressure difference over 0.2 bars.	Check sensors P1 and P2. Calibrate sensors P1 and P2.
50	Unloading door's interlock opened during cycle.	Check interlock's microswitches. Check interlock's solenoid and function.
51	Unloading door is not closed.	Check door's microswitch. Check door's function.
52	Electric board temperature is too high.	Automatic thermostat max 50 °C on electric board. Ambient temperature > 50 °C? Change the air inlet filter?
58	Water conductivity above the set value	Check the quality of pure water. Check the function of conductivity meter and calibrate when necessary.

11 APPENDIX II: USER AND MAINTENANCE INSTRUCTIONS.

USER INSTRUCTIONS

Replacing detergent containers	38
Cleaning spray arms & nozzles	38
Checking free rotation of the wash arms	39
Checking functioning of wash arm water connectors	39
Cleaning outlet filter	39

Replacement of detergent containers



1. Take out the detergent container
2. Remove suction hose from the detergent container.
3. Replace the container.
4. For controlling the consumption of detergent, it is recommended to mark with date the level



When you handle process chemicals - wear protection gloves and follow the suppliers' safety instructions.

Cleaning spray arms & nozzles



1. Unscrew the locking screw and push the clips down to remove the wash arm.
2. Open the caps (turn and pull) at both ends of the arm and clean thoroughly.

Free rotation of wash arms

Wash arm water connector

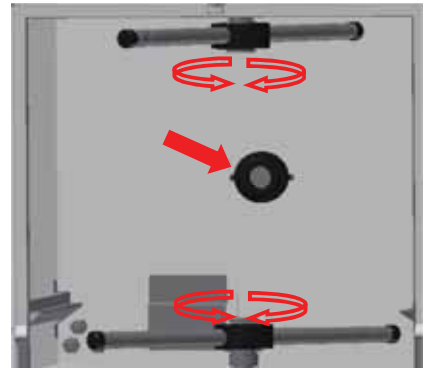
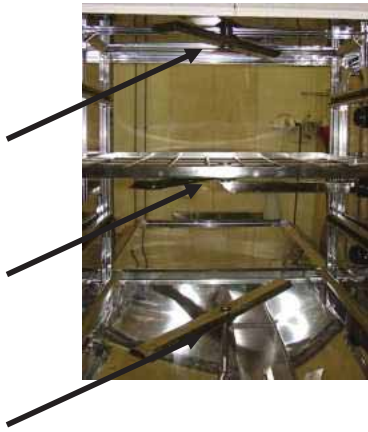

1. Check that each wash arm rotates freely.

1. Check the operation of the water connector by pressing/releasing it.
2. Detach and clean if necessary.

Cleaning the outlet filter

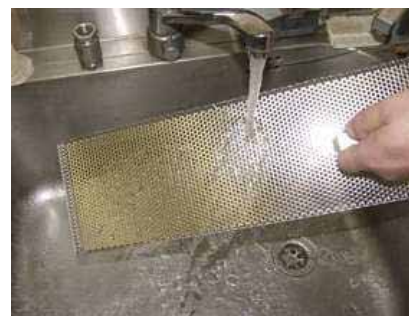

1. Remove the filter by lifting.

2. Flush and clean.



Rhima Australia Pty Ltd

ABN 63 007 242 604

72-74 Woodlands Drive Braeside 3195

PO Box 605 Braeside Vic 3195

Tel: 1800 659 292 or 03 8586 5444

Fax: 03 8586 5454

www.rhima.com.au